

# DATA SHEET

# NEC

# GaAs INTEGRATED CIRCUIT $\mu$ PG2179TB

## L, S-BAND SPDT SWITCH

### DESCRIPTION

The  $\mu$ PG2179TB is a GaAs MMIC for L, S-band SPDT (Single Pole Double Throw) switch which were developed for mobile phone and another L, S-band application. This device can operate 2 control switching by control voltage 2.5 to 5.3 V. This device can operate frequency from 0.05 to 3.0 GHz, having the low insertion loss and high isolation.

This device is housed in a 6-pin super minimold package. And this package is able to high-density surface mounting.

### ★ FEATURES

- Switch control voltage :  $V_{\text{cont (H)}} = 2.5 \text{ to } 5.3 \text{ V (3.0 V TYP.)}$   
:  $V_{\text{cont (L)}} = -0.2 \text{ to } +0.2 \text{ V (0 V TYP.)}$
- Low insertion loss :  $L_{\text{ins1}} = 0.25 \text{ dB TYP. @ } f = 0.05 \text{ to } 1.0 \text{ GHz, } V_{\text{cont (H)}} = 3.0 \text{ V, } V_{\text{cont (L)}} = 0 \text{ V}$   
:  $L_{\text{ins2}} = 0.30 \text{ dB TYP. @ } f = 1.0 \text{ to } 2.0 \text{ GHz, } V_{\text{cont (H)}} = 3.0 \text{ V, } V_{\text{cont (L)}} = 0 \text{ V}$   
:  $L_{\text{ins3}} = 0.35 \text{ dB TYP. @ } f = 2.0 \text{ to } 2.5 \text{ GHz, } V_{\text{cont (H)}} = 3.0 \text{ V, } V_{\text{cont (L)}} = 0 \text{ V}$   
:  $L_{\text{ins4}} = 0.40 \text{ dB TYP. @ } f = 2.5 \text{ to } 3.0 \text{ GHz, } V_{\text{cont (H)}} = 3.0 \text{ V, } V_{\text{cont (L)}} = 0 \text{ V}$
- High isolation :  $\text{ISL1} = 27 \text{ dB TYP. @ } f = 0.05 \text{ to } 2.0 \text{ GHz, } V_{\text{cont (H)}} = 3.0 \text{ V, } V_{\text{cont (L)}} = 0 \text{ V}$   
:  $\text{ISL2} = 24 \text{ dB TYP. @ } f = 2.0 \text{ to } 3.0 \text{ GHz, } V_{\text{cont (H)}} = 3.0 \text{ V, } V_{\text{cont (L)}} = 0 \text{ V}$
- Handling power :  $P_{\text{in (0.1 dB)}} = +29.0 \text{ dBm TYP. @ } f = 0.5 \text{ to } 3.0 \text{ GHz, } V_{\text{cont (H)}} = 3.0 \text{ V, } V_{\text{cont (L)}} = 0 \text{ V}$   
:  $P_{\text{in (1 dB)}} = +32.0 \text{ dBm TYP. @ } f = 0.5 \text{ to } 3.0 \text{ GHz, } V_{\text{cont (H)}} = 3.0 \text{ V, } V_{\text{cont (L)}} = 0 \text{ V}$
- High-density surface mounting : 6-pin super minimold package (2.0 × 1.25 × 0.9 mm)

### APPLICATIONS

- L, S-band digital cellular or cordless telephone
- PCS, W-LAN, WLL and Bluetooth™ etc.

### ★ ORDERING INFORMATION

Part Number	Package	Marking	Supplying Form
$\mu$ PG2179TB-E4	6-pin super minimold	G4C	<ul style="list-style-type: none"><li>• Embossed tape 8 mm wide</li><li>• Pin 4, 5, 6 face the perforation side of the tape</li><li>• Qty 3 kpcs/reel</li></ul>

**Remark** To order evaluation samples, contact your nearby sales office.

Part number for sample order:  $\mu$ PG2179TB

**Caution** Observe precautions when handling because these devices are sensitive to electrostatic discharge.

The information in this document is subject to change without notice. Before using this document, please confirm that this is the latest version.  
Not all devices/types available in every country. Please check with local NEC Compound Semiconductor Devices representative for availability and additional information.

**PIN CONNECTIONS AND INTERNAL BLOCK DIAGRAM**

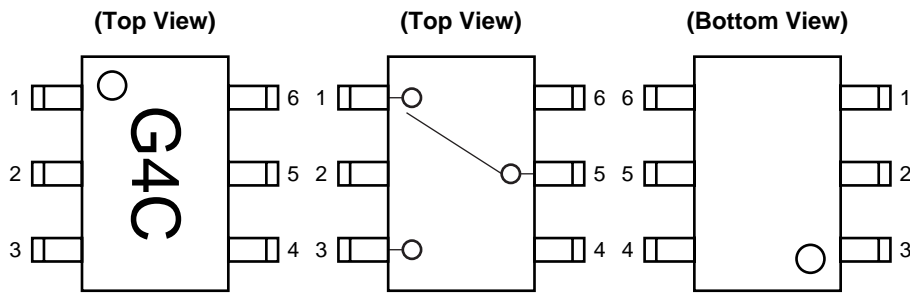

Pin No.	Pin Name
1	OUTPUT1
2	GND
3	OUTPUT2
4	V <sub>cont2</sub>
5	INPUT
6	V <sub>cont1</sub>

**TRUTH TABLE**

V <sub>cont1</sub>	V <sub>cont2</sub>	INPUT-OUTPUT1	INPUT-OUTPUT2
Low	High	ON	OFF
High	Low	OFF	ON

**ABSOLUTE MAXIMUM RATINGS (T<sub>A</sub> = +25°C, unless otherwise specified)**

Parameter	Symbol	Ratings	Unit
Switch Control Voltage	V <sub>cont</sub>	6.0 <sup>Note</sup>	V
Input Power	P <sub>in</sub>	+33	dBm
Operating Ambient Temperature	T <sub>A</sub>	-45 to +85	°C
Storage Temperature	T <sub>stg</sub>	-55 to +150	°C

★ **Note** |V<sub>cont1</sub> - V<sub>cont2</sub>| ≤ 6.0 V

**RECOMMENDED OPERATING RANGE (T<sub>A</sub> = +25°C, unless otherwise specified)**

Parameter	Symbol	MIN.	TYP.	MAX.	Unit
Switch Control Voltage (H)	V <sub>cont (H)</sub>	2.5	3.0	5.3	V
Switch Control Voltage (L)	V <sub>cont (L)</sub>	-0.2	0	0.2	V

★ ELECTRICAL CHARACTERISTICS

(T<sub>A</sub> = +25°C, V<sub>cont</sub> (H) = 3.0 V, V<sub>cont</sub> (L) = 0 V, DC cut capacitors = 100 pF, unless otherwise specified)

Parameter	Symbol	Test Conditions	MIN.	TYP.	MAX.	Unit
Insertion Loss 1	L <sub>ins1</sub>	f = 0.05 to 1.0 GHz <sup>Note1</sup>	–	0.25	0.45	dB
Insertion Loss 2	L <sub>ins2</sub>	f = 1.0 to 2.0 GHz	–	0.30	0.50	dB
Insertion Loss 3	L <sub>ins3</sub>	f = 2.0 to 2.5 GHz	–	0.35	0.55	dB
Insertion Loss 4	L <sub>ins4</sub>	f = 2.5 to 3.0 GHz	–	0.40	0.60	dB
Isolation 1	ISL1	f = 0.05 to 2.0 GHz <sup>Note1</sup>	23	27	–	dB
Isolation 2	ISL2	f = 2.0 to 3.0 GHz	20	24	–	dB
Input Return Loss	RL <sub>in</sub>	f = 0.05 to 3.0 GHz <sup>Note1</sup>	15	20	–	dB
Output Return Loss	RL <sub>out</sub>	f = 0.05 to 3.0 GHz <sup>Note1</sup>	15	20	–	dB
0.1 dB Loss Compression Input Power <sup>Note2</sup>	P <sub>in (0.1 dB)</sub>	f = 2.0 GHz	+25.5	+29.0	–	dBm
		f = 2.5 GHz	+25.5	+29.0	–	dBm
		f = 0.5 to 3.0 GHz	–	+29.0	–	dBm
Switch Control Current	I <sub>cont</sub>	No signal	–	4	20	μA
Switch Control Speed	t <sub>sw</sub>	50%CTL to 90/10%RF	–	50	500	ns

**Note1.** DC cut capacitor = 1 000 pF at f = 0.05 to 0.5 GHz.

**2.** P<sub>in (0.1 dB)</sub> is measured the input power level when the insertion loss increases more 0.1 dB than that of linear range.

★ STANDARD CHARACTERISTICS FOR REFERENCE

(T<sub>A</sub> = +25°C, V<sub>cont</sub> (H) = 3.0 V, V<sub>cont</sub> (L) = 0 V, DC cut capacitors = 100 pF, unless otherwise specified)

Parameter	Symbol	Test Conditions	MIN.	TYP.	MAX.	Unit
1 dB Loss Compression Input Power <sup>Note</sup>	P <sub>in (1 dB)</sub>	f = 0.5 to 3.0 GHz	–	+32.0	–	dBm
3rd Order Intermodulation Intercept Point	IIP <sub>3</sub>	f = 0.5 to 3.0 GHz, 2 tone, 5 MHz spicing	–	+60.0	–	dBm

**Note** P<sub>in (1 dB)</sub> is measured the input power level when the insertion loss increases more 1 dB than that of linear range.

★ **Caution** When using this IC, a DC coupling capacitor must be externally attached to the I/O pins.

A DC coupling capacitor with a capacitance of 100 pF or lower is recommended when using a frequency of 0.5 GHz or higher, and one with a capacitance of 1,000 pF is recommended when using a frequency of less than 0.5 GHz. The ideal value changes depending on the frequency and bandwidth used, so select a capacitor with a suitable capacitance according to the usage conditions.

★ EVALUATION CIRCUIT

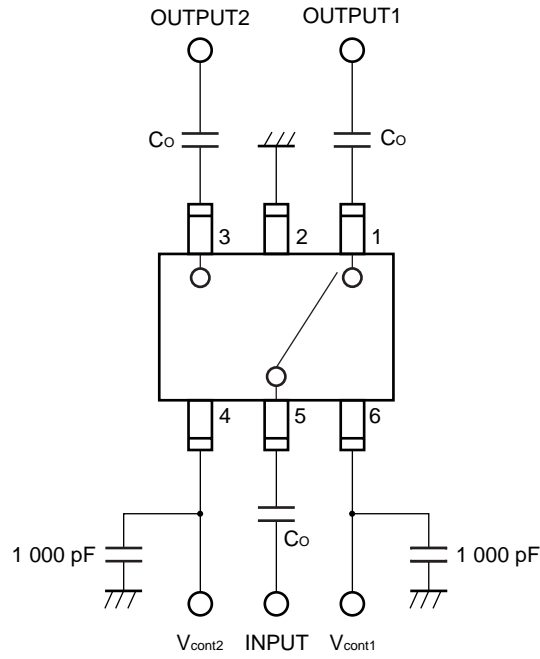

**Remark** Co : 0.05 to 0.5 GHz 1 000 pF  
 0.5 to 3.0 GHz 100 pF

The application circuits and their parameters are for reference only and are not intended for use in actual design-ins.

★ ILLUSTRATION OF THE TEST CIRCUIT ASSEMBLED ON EVALUATION BOARD

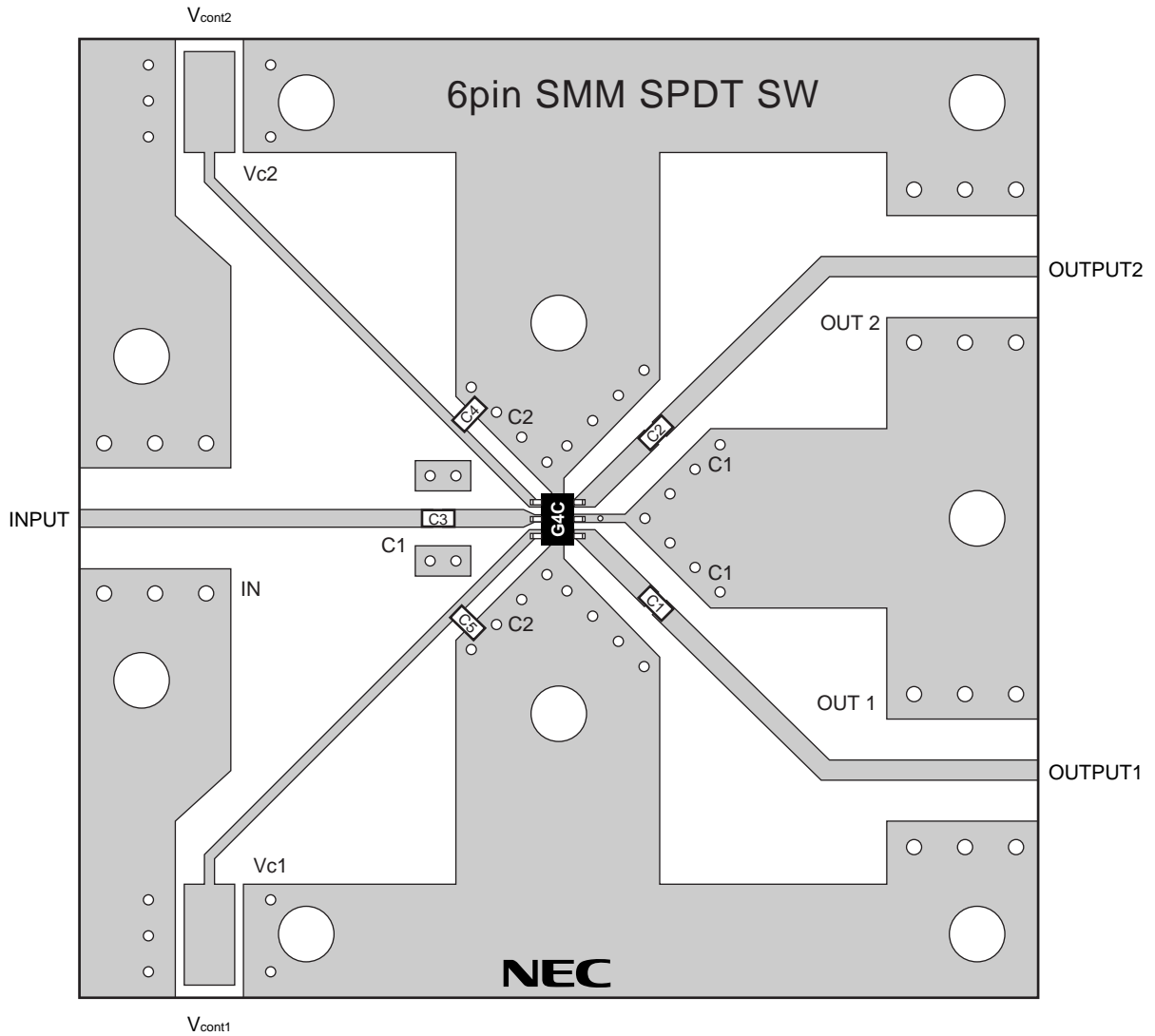

USING THE NEC EVALUATION BOARD

Symbol	Values
C1, C2, C3	100 pF
C4, C5	1 000 pF

**TYPICAL CHARACTERISTICS**

★ (TA = +25°C, Vcont (H) = 3.0 V, Vcont (L) = 0 V, DC cut capacitors = 100 pF, unless otherwise specified)

INPUT-OUTPUT1  
INSERTION LOSS vs. FREQUENCY

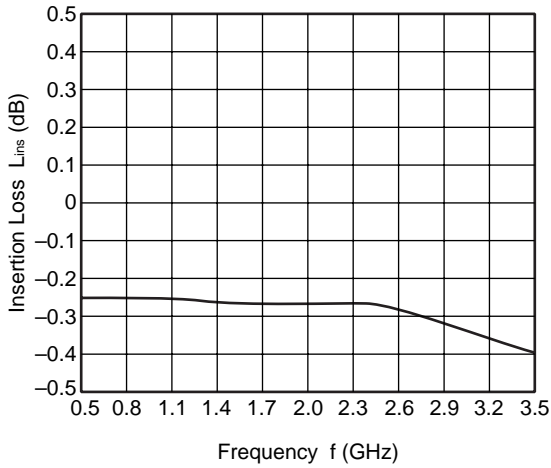

INPUT-OUTPUT2  
INSERTION LOSS vs. FREQUENCY

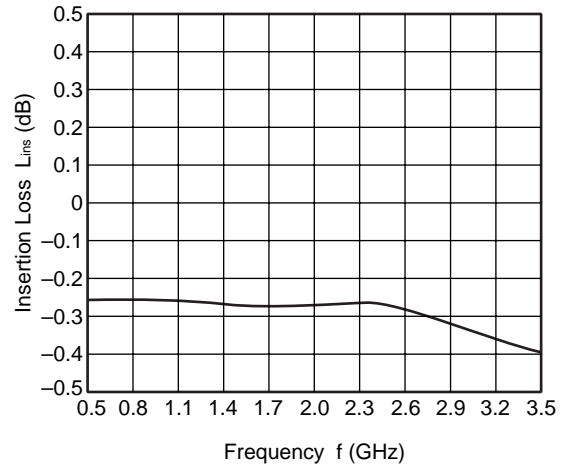

INPUT-OUTPUT1  
ISOLATION vs. FREQUENCY

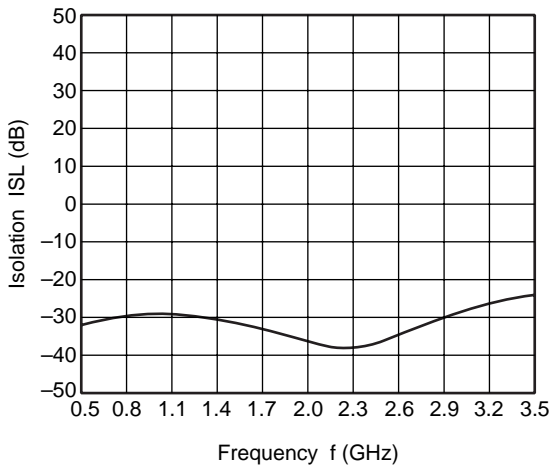

INPUT-OUTPUT2  
ISOLATION vs. FREQUENCY

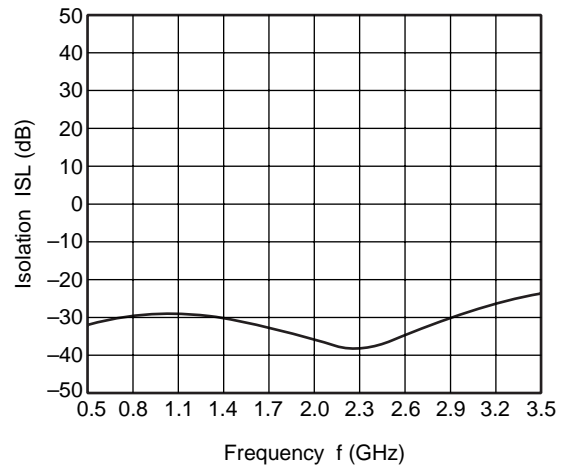

INPUT-OUTPUT1  
INPUT RETURN LOSS vs. FREQUENCY

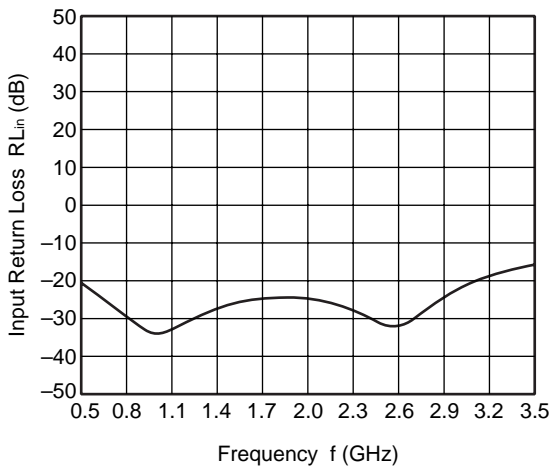

INPUT-OUTPUT2  
INPUT RETURN LOSS vs. FREQUENCY

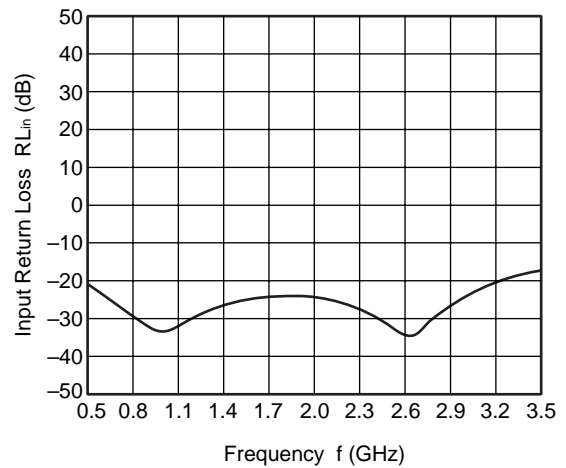

**Remark** The graphs indicate nominal characteristics.

INPUT-OUTPUT1  
OUTPUT RETURN LOSS vs. FREQUENCY

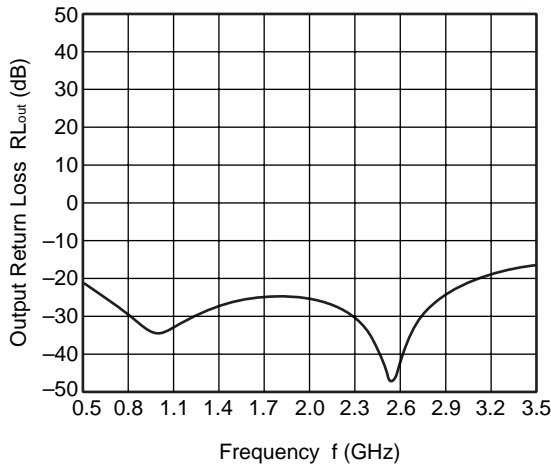

INPUT-OUTPUT2  
OUTPUT RETURN LOSS vs. FREQUENCY

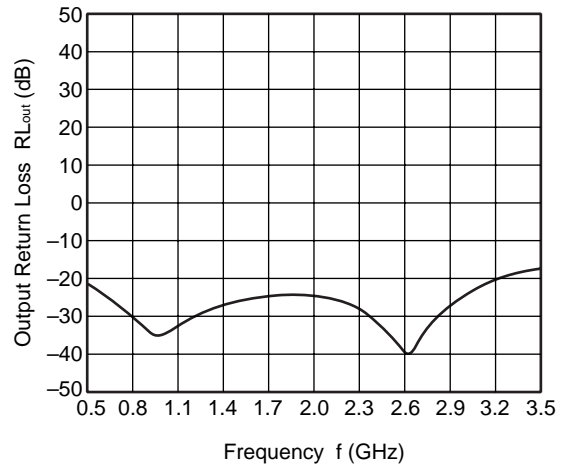

OUTPUT POWER vs. INPUT POWER

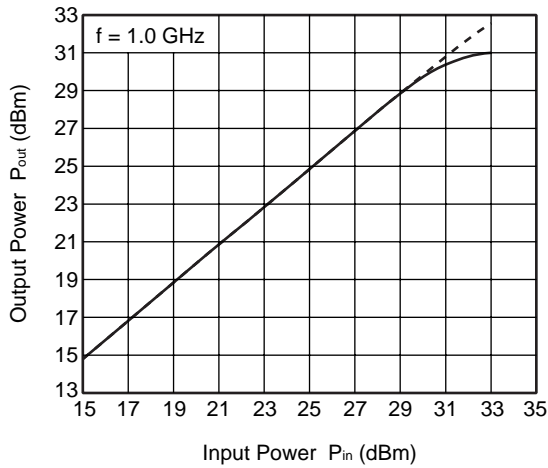

OUTPUT POWER vs. INPUT POWER

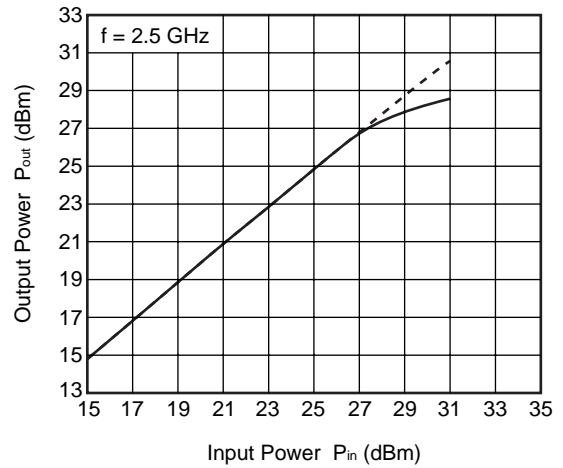

**Remark** The graphs indicate nominal characteristics.

PACKAGE DIMENSIONS

6-PIN SUPER MINIMOLD (UNIT: mm)

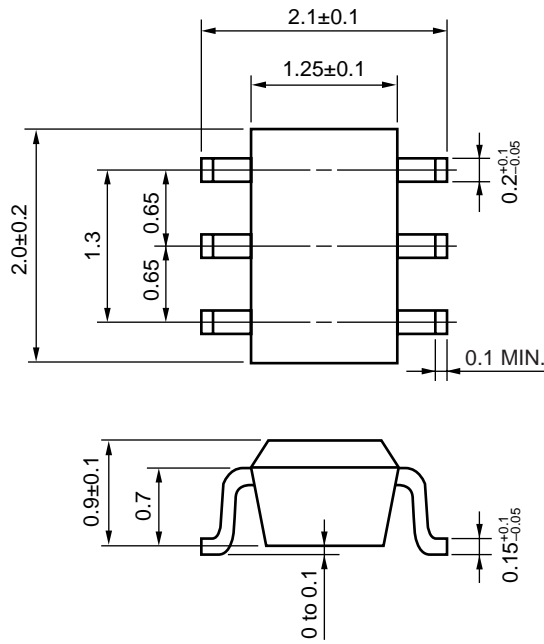



**RECOMMENDED SOLDERING CONDITIONS**

This product should be soldered and mounted under the following recommended conditions. For soldering methods and conditions other than those recommended below, contact your nearby sales office.

Soldering Method	Soldering Conditions	Condition Symbol
Infrared Reflow	Peak temperature (package surface temperature) : 260°C or below Time at peak temperature : 10 seconds or less Time at temperature of 220°C or higher : 60 seconds or less Preheating time at 120 to 180°C : 120±30 seconds Maximum number of reflow processes : 3 times Maximum chlorine content of rosin flux (% mass) : 0.2%(Wt.) or below	IR260
VPS	Peak temperature (package surface temperature) : 215°C or below Time at temperature of 200°C or higher : 25 to 40 seconds Preheating time at 120 to 150°C : 30 to 60 seconds Maximum number of reflow processes : 3 times Maximum chlorine content of rosin flux (% mass) : 0.2%(Wt.) or below	VP215
Wave Soldering	Peak temperature (molten solder temperature) : 260°C or below Time at peak temperature : 10 seconds or less Preheating temperature (package surface temperature) : 120°C or below Maximum number of flow processes : 1 time Maximum chlorine content of rosin flux (% mass) : 0.2%(Wt.) or below	WS260
Partial Heating	Peak temperature (pin temperature) : 350°C or below Soldering time (per side of device) : 3 seconds or less Maximum chlorine content of rosin flux (% mass) : 0.2%(Wt.) or below	HS350

**Caution Do not use different soldering methods together (except for partial heating).**

Bluetooth is a trademark owned by Bluetooth SIG, Inc., U.S.A.

- **The information in this document is current as of March, 2004. The information is subject to change without notice. For actual design-in, refer to the latest publications of NEC's data sheets or data books, etc., for the most up-to-date specifications of NEC semiconductor products. Not all products and/or types are available in every country. Please check with an NEC sales representative for availability and additional information.**
  - No part of this document may be copied or reproduced in any form or by any means without prior written consent of NEC. NEC assumes no responsibility for any errors that may appear in this document.
  - NEC does not assume any liability for infringement of patents, copyrights or other intellectual property rights of third parties by or arising from the use of NEC semiconductor products listed in this document or any other liability arising from the use of such products. No license, express, implied or otherwise, is granted under any patents, copyrights or other intellectual property rights of NEC or others.
  - Descriptions of circuits, software and other related information in this document are provided for illustrative purposes in semiconductor product operation and application examples. The incorporation of these circuits, software and information in the design of customer's equipment shall be done under the full responsibility of customer. NEC assumes no responsibility for any losses incurred by customers or third parties arising from the use of these circuits, software and information.
  - While NEC endeavours to enhance the quality, reliability and safety of NEC semiconductor products, customers agree and acknowledge that the possibility of defects thereof cannot be eliminated entirely. To minimize risks of damage to property or injury (including death) to persons arising from defects in NEC semiconductor products, customers must incorporate sufficient safety measures in their design, such as redundancy, fire-containment, and anti-failure features.
  - NEC semiconductor products are classified into the following three quality grades:  
"Standard", "Special" and "Specific". The "Specific" quality grade applies only to semiconductor products developed based on a customer-designated "quality assurance program" for a specific application. The recommended applications of a semiconductor product depend on its quality grade, as indicated below. Customers must check the quality grade of each semiconductor product before using it in a particular application.  
"Standard": Computers, office equipment, communications equipment, test and measurement equipment, audio and visual equipment, home electronic appliances, machine tools, personal electronic equipment and industrial robots  
"Special": Transportation equipment (automobiles, trains, ships, etc.), traffic control systems, anti-disaster systems, anti-crime systems, safety equipment and medical equipment (not specifically designed for life support)  
"Specific": Aircraft, aerospace equipment, submersible repeaters, nuclear reactor control systems, life support systems and medical equipment for life support, etc.
- The quality grade of NEC semiconductor products is "Standard" unless otherwise expressly specified in NEC's data sheets or data books, etc. If customers wish to use NEC semiconductor products in applications not intended by NEC, they must contact an NEC sales representative in advance to determine NEC's willingness to support a given application.
- (Note)
- (1) "NEC" as used in this statement means NEC Corporation, NEC Compound Semiconductor Devices, Ltd. and also includes its majority-owned subsidiaries.
  - (2) "NEC semiconductor products" means any semiconductor product developed or manufactured by or for NEC (as defined above).

M8E 00.4-0110

<p><b>Caution</b></p>	<p>GaAs Products</p>	<p>This product uses gallium arsenide (GaAs). GaAs vapor and powder are hazardous to human health if inhaled or ingested, so please observe the following points.</p> <ul style="list-style-type: none"> <li>• Follow related laws and ordinances when disposing of the product. If there are no applicable laws and/or ordinances, dispose of the product as recommended below.               <ol style="list-style-type: none"> <li>1. Commission a disposal company able to (with a license to) collect, transport and dispose of materials that contain arsenic and other such industrial waste materials.</li> <li>2. Exclude the product from general industrial waste and household garbage, and ensure that the product is controlled (as industrial waste subject to special control) up until final disposal.</li> </ol> </li> <li>• Do not burn, destroy, cut, crush, or chemically dissolve the product.</li> <li>• Do not lick the product or in any way allow it to enter the mouth.</li> </ul>
-----------------------	----------------------	---

► For further information, please contact

**NEC Compound Semiconductor Devices, Ltd.** <http://www.ncsd.necel.com/>

E-mail: salesinfo@ml.ncsd.necel.com (sales and general)

techinfo@ml.ncsd.necel.com (technical)

5th Sales Group, Sales Division TEL: +81-44-435-1588 FAX: +81-44-435-1579

**NEC Compound Semiconductor Devices Hong Kong Limited**

E-mail: ncsd-hk@elhk.nec.com.hk (sales, technical and general)

Hong Kong Head Office TEL: +852-3107-7303 FAX: +852-3107-7309

Taipei Branch Office TEL: +886-2-8712-0478 FAX: +886-2-2545-3859

Korea Branch Office TEL: +82-2-558-2120 FAX: +82-2-558-5209

**NEC Electronics (Europe) GmbH** <http://www.ee.nec.de/>

TEL: +49-211-6503-0 FAX: +49-211-6503-1327

**California Eastern Laboratories, Inc.** <http://www.cel.com/>

TEL: +1-408-988-3500 FAX: +1-408-988-0279